

Magneetsnappers MC 9 serie

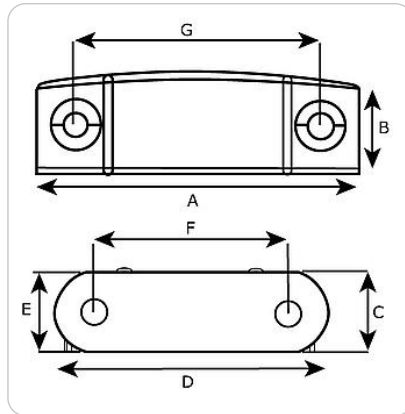

Eigenschappen

materiaal
materiaal tegenplaat
bevestiging
soort magneet











slagvaste kunststof
slagvaste kunststof
opschroevend
permanentmagneet

Verkooppunten

Vind een verkooppunt bij u in de buurt



Productfilter

Artikelnummer	Labelcode	MBH	magneetkracht (kg)	A (mm)	B (mm)	C (mm)	D (mm)	E (mm)	F (mm)	G (mm)	kleur	verpakking	Bestel/Offerte
0414.700.3002	 MC 9302B	20	3	55	11	15	55	15	40	40	wit		<input type="text" value="20"/>
0414.700.3003	 MC 9303B	20	3	55	11	15	55	15	40	40	bruin		<input type="text" value="20"/>
0414.700.4002	 MC 9402B	20	4	56	12	16	56	15	42	42	wit		<input type="text" value="20"/>
0414.700.4003	 MC 9403B	20	4	56	12	16	56	15	42	42	bruin		<input type="text" value="20"/>
0414.700.6002	 MC 9602B	20	6	62	13	16	62	16	44	44	wit		<input type="text" value="20"/>
0414.700.6003	 MC 9603B	20	6	62	13	16	62	16	44	44	bruin		<input type="text" value="20"/>
0414.700.1202	 MC 91202B	10	12	80	16	20	80	20	64	60	wit		<input type="text" value="10"/>
0414.700.1203	 MC 91203B	10	12	80	16	20	80	20	64	60	bruin		<input type="text" value="10"/>
5414.700.3002	 MC 9302B ZK	5	3	55	11	15	55	15	40	40	wit	zak à 4 stuks	<input type="text" value="5"/>
5414.700.4002	 MC 9402B ZK	5	4	56	12	16	56	15	42	42	wit	zak à 4 stuks	<input type="text" value="5"/>
5414.700.6002	 MC 9602B ZK	5	6	62	13	16	62	16	44	44	wit	zak à 4 stuks	<input type="text" value="5"/>